

ELECTRONIC DATA INTERCHANGE WITH FORD

EDI BROCHURE



created by **GSEC**, Global Supplier Electronic Communications



Originator: GSEC
File name: GSEC-A-D-002

Page 1 of 23
GIS 25.03 S+1

Date Issued: 16.09.2004
Date Revised: 20.11.2012
Version: 3

Brochure map

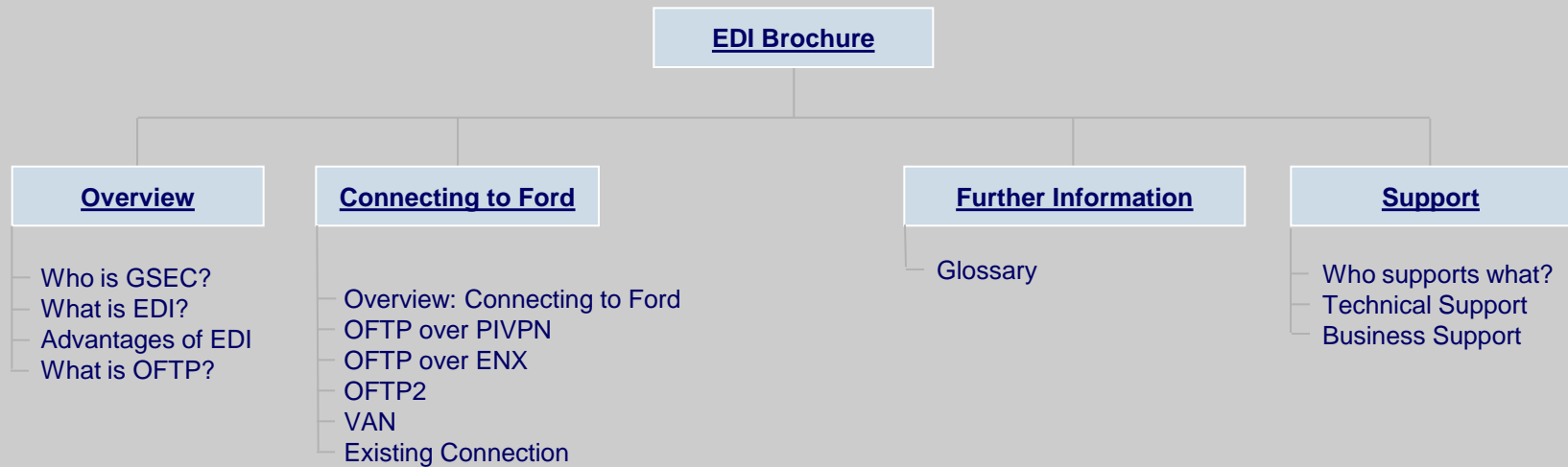

Who is GSEC?



Global Supplier Electronic Communications

Mission Statement	GSEC is a single point of contact for trading partners of any kind that delivers reliable, efficient and secure network connections.
Background	<p>The Global Supplier Electronic Communications (GSEC) organization was established to be the primary interface between Ford and its suppliers in matters relating to the transfer of electronic data and external access to Ford applications and servers.</p> <p>We support more than 5,000 trading partners in over 20 countries.</p> <p>GSEC provides communication support for Electronic Data Interchange (EDI) and network connectivity to Ford Network.</p>
Strategic Direction	Ford's strategic direction is to use OFTPv1 and OFTPv2 as the EDI Transmission Protocols in EU and PI-VPN or ENX/ANX as the network connection with their Trading Partners.
GSEC offices	Locations in Europe and USA



What is EDI?

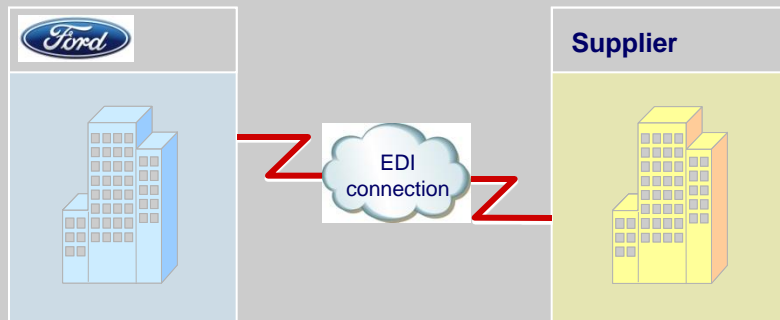

- ⇒ EDI consists of standardized electronic message formats (called transaction sets) replacing or enhancing common business documents and communications. These electronic transaction sets enable the computer in a company or organization to communicate with a computer in another organization without human intervention and paper consumption.
- ⇒ EDI is more than a computer-to-computer communication and more than simple freeform electronic mail messages. EDI communications go from one application (business system) to another in a way that information does not have to be retyped. For example, using EDI, orders go directly from one company's purchasing system to another company's order entry system.

Advantages of EDI

- ⇒ Accuracy, visibility of information and reduction of lead times, administration, stocks and costs.
- ⇒ Quick response to avoid disruption in supply chain.
- ⇒ Reduces costs related to business transactions handling. *EDI eliminates manual sorting, matching, filing, reconciling, and mailing tasks. EDI dramatically reduces the number of errors.*
- ⇒ Reduced cycle/pay period. By eliminating use of regular mail and by decreasing the time needed to process an order transaction, products can be shipped and invoiced sooner.



What is OFTP?

Odette File Transfer Protocol (OFTP) it is a protocol used for automated EDI transmission between two Trading Partners. It is a high level protocol applied to the way in which files and messages are sent. It is not involved in defining the physical communications channel the data travels through.

Value Added Network (VAN) it is a hosted service that acts as an intermediary between business partners sharing EDI data.

•Direct Connection:

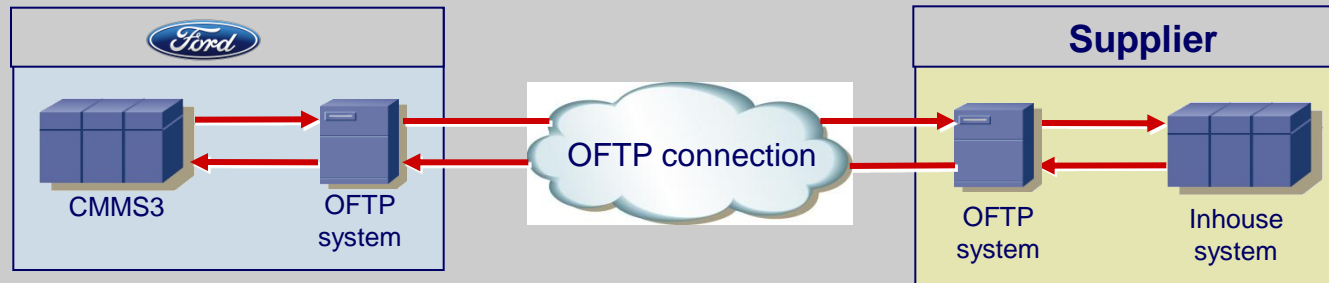

•Indirect Connection (through VAN):

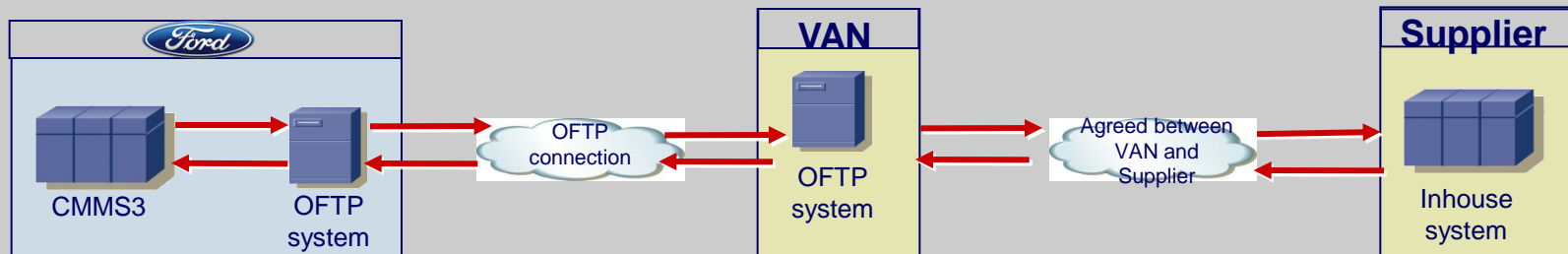

Overview: Connecting to Ford

Connection options:

In order to establish an EDI connection to Ford, you have the choice of the following connection types:

Direct Connection to Ford

- ⇒ **OFTP** over
 - ⇒ PIVPN
 - ⇒ ENX

The security of the OFTP connection relies on the network connection. Therefore it can not work over Public Internet. A PIVPN or ENX connection must implemented.

- ⇒ **OFTP2** (over Public Internet).

OFTP2 is an extension of the OFTP (Odette File Transfer Protocol). It provides strong authentication and encryption and can therefore be used directly over Public Internet.

ENX or PIVPN network connections are not required with this option.

Indirect Connection to Ford

- ⇒ **VAN**

It is a hosted service that acts as an intermediary between business partners sharing EDI data. The connection between the VAN and Ford will be through OFTP(or OFTP2). The connection between VAN and the Trading Partner must be agreed between them.

- ⇒ **Existing connection**

If one of your company sites has already a connection with Ford, it can be used to transfer EDI files to Ford.



OFTP over a PIVPN Connection

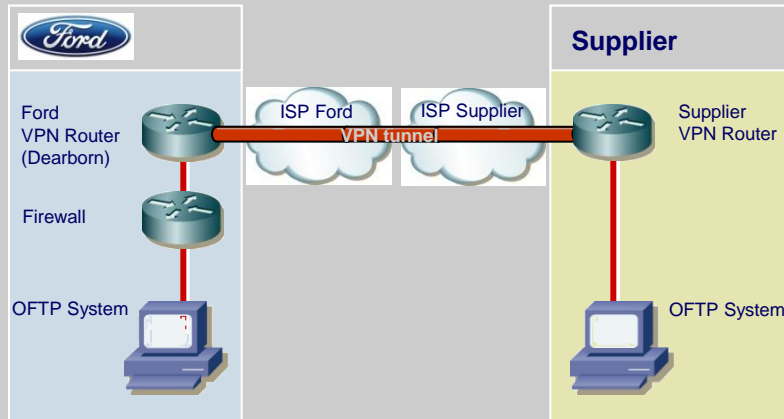

Description

- Ford OFTP software connects to supplier OFTP software and sends EDI files
- Supplier connects to Ford OFTP server to submit EDI files.
- All this traffic is done over a secure VPN tunnel.

Requirements for supplier

Application:

- OFTP software.

Network:

- Public Internet connection
- Static Public IP address(es) for IPSEC Gateway
- IPsec device (router, firewall...)

Recurring costs

- IPsec device maintenance costs (if applicable).
- OFTP software license (if applicable).

Timing

- PIVPN connection in Ford is set up in 2 weeks after Trading Partner (TP) has sent his configuration details.
- EDI configuration at Ford takes 1 week after the PIVPN connection is established and the TP has sent the OFTP license.

Further info:

<https://www.supppcomm.ford.com/europe/connection/pivpn.asp>

+	-
<ul style="list-style-type: none">- Low cost connection- Worldwide connection through Public Internet.	<ul style="list-style-type: none">- Trading Partner must have the necessary expertise to configure the connection.- There is no SLA (Service Level Agreement) covering performance, availability or access.



OFTP over an ENX Connection

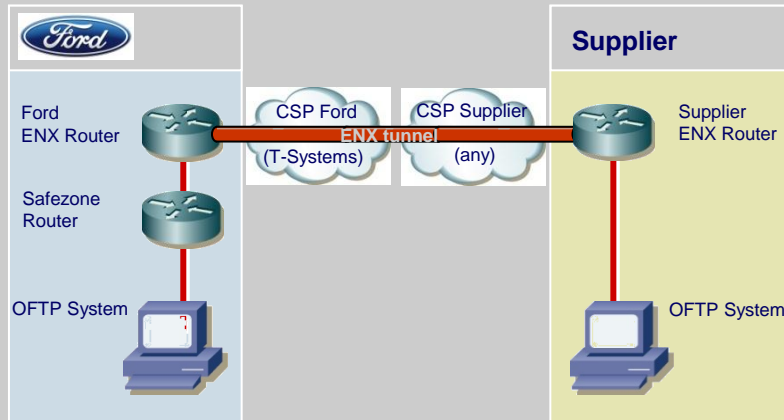

Function

- Ford OFTP software connects to supplier OFTP software and sends EDI files.
- Supplier connects to Ford OFTP server to submit EDI files
- All this traffic is done over a secure ENX connection.

Requirements for supplier

Application:

- OFTP software.

Network:

- ENX connection.

Recurring costs

- Depending on connection type, bandwidth and country.
- OFTP software license (if applicable).

Timing

- Setup for ENX connection takes 6-8 weeks
- EDI implementation at Ford takes 1 week after supplier completed his setups and GSEC received completed and signed OFTP license.

Further info:

<https://www.supppcomm.ford.com/europe/connection/enx.asp>

+

- Available in most European countries
- Variable bandwidth
- Reliable technology
- One ENX connection can be used to connect to several OEMs

-

- Expensive compared to PIVPN connection.
- Lead time for connection, if ENX connection is not yet implemented



OFTP2

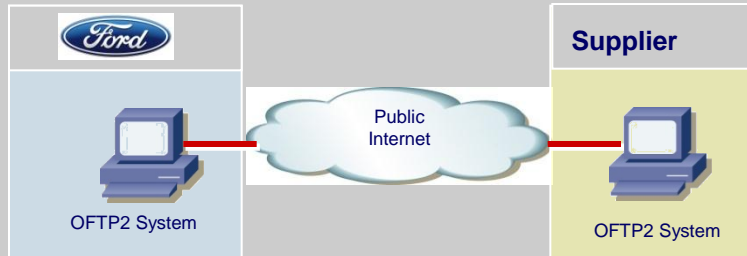

Function

- Ford OFTP2 software connects to supplier OFTP2 software and sends EDI files
- Supplier connects to Ford OFTP2 server to submit EDI files.
- The OFTP2 software uses the digital certificate to encrypt the connection.

Requirements for supplier

Application

- OFTP2 software.
- Digital Certificate.

Network

- Public Internet connection.
- It can also work over PIVPN or ENX

Recurring costs

- OFTP2 software license (if applicable).
- Digital Certificate (if applicable).

Timing

- OFTP2 configuration at Ford takes 1 week after the Trading Partner has sent the OFTP license.

Further info:

<https://www.supppcomm.ford.com/europe/connection/oftp2.asp>

+	-
<ul style="list-style-type: none">- Low cost connection- Easy to implement.- Worldwide connection through Public Internet .- Ford recommended EDI connection method.- Additional security options: It can encrypt and sign the EDI files	<ul style="list-style-type: none">- In some cases OFTP2 software is slightly more expensive than OFTP1.



Connection using a VAN Service Provider

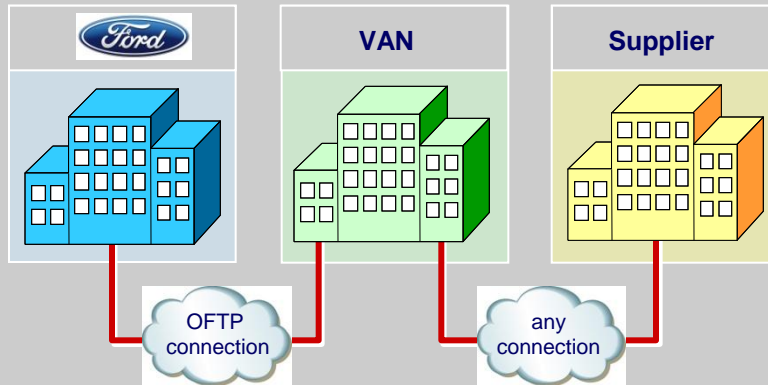

Function

- Ford OFTP software connects to VAN OFTP software and sends EDI files. The VAN forwards the EDI files to the Supplier.
- Supplier submits files to the VAN and the VAN forwards ASNs to Ford.

Requirements for supplier

- Supplier needs to find a VAN and establish data link with them that meets Ford Business requirements (e.g. send ASNs to Ford within 15 minutes).

Recurring costs

- Depending on the VAN cost.

Timing

- 1 week after the supplier and the VAN completed their setup and GSEC receives the completed OFTP license.

Important notes

- FORD will not be liable for any problems caused by the VAN provider chosen by the TP.
- It is the TP's responsibility to assure the correct transmission of the EDI data through the systems of the VAN provider.
- FORD reserves the right to disconnect a VAN from FORD in case of problems regarding security or quality of service.

Further info:

<https://www.supcomm.ford.com/europe/connection/van.asp>

+

- Supplier can arrange any technical connection with the VAN
- Supplier can arrange any data format with the VAN

-

- Additional cost for the VAN service
- Highly dependent on the VAN



Using Existing Connection to Ford

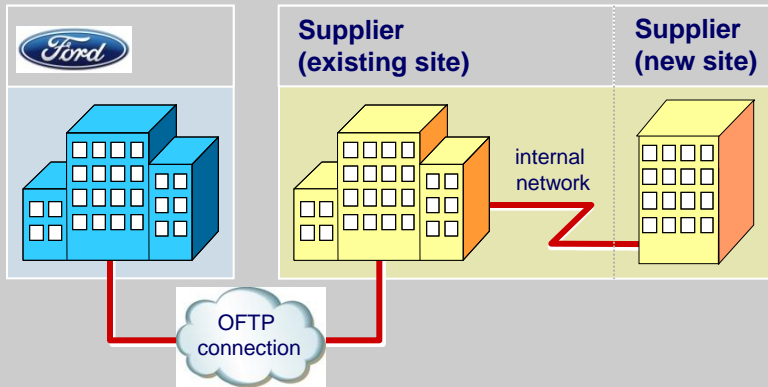

Scenarios

1. A new site needs to receive its own EDI files. In that case the existing site will work as a "VAN". How can the existing site discriminate the new-site EDI files from their owns?
 - Checking the supplier code (GSDB) in the EDI file
 - Using a different SFID code for the new site
 - Checking the Virtual File Name (VFN) that Ford will use for the new location
2. A new site does not require to receive EDI files. The existing site will receive and integrate the files into the company ERP system.

Function

- Ford sends EDI files to the existing site. The existing site processes data according to selected scenario. New site receives data from existing site.
- The new site submits EDI files (e.g. ASN) to the existing site. The existing site forwards ASNs to Ford.

Requirements

- Supplier's EDI systems need to support one of the above scenarios.

Recurring costs

- Depending on supplier's EDI system.

Timing

- 1 week after supplier completed the setups and GSEC received completed and signed OFTP license.

+

- Short implementation time
- Low implementation cost
- Supplier's EDI system is already adjusted to Ford's requirements

-

- If the single connection is down, all sites are disconnected and will not receive data



Glossary - Part 1 of 2

EDI	Electronic Data Interchange, the computer-to-computer exchange of structured information, by agreed message standards, from one computer application to another by electronic means and with a minimum of human intervention.
ENX	European Network eXchange is both the name for the company and the name for the product. Representatives of the European Automotive Industry have agreed on a joint initiative to create a network better than the Internet.
ERP	Enterprise Resource Planning. Completely integrated software solution for manufacturing, finance, logistics, staff management and marketing. ERP systems usually cover all areas of a company and are designed modular.
GSEC	Global Supplier Electronic Communications, a single point of contact for trading partners that delivers reliable, efficient and secure network connections.
ISP	Internet Service Provider, a provider of Internet services. Most telecommunications operators are ISPs. They provide services like internet transit, domain name registration and hosting, dial-up access and leased line access.
ODETTE	The Organisation for Data Exchange by Tele-Transmission in Europe is a standards-making body which has developed standards in the areas of EDI communications (notably the OFTP), as well as message standards. For further information visit http://www.odette.org
OEM	Original Equipment Manufacturer, a company that builds components that are used in systems sold by another company called a value-added reseller.
OFTP	ODETTE File Transfer Protocol is the most common protocol used for EDI file transfer throughout Europe.
SSID	Also known as Odette ID code. This is the ID of the OFTP (or OFTP2) software.
SFID	This is the OFTP ID of the file final destination. In the most simple case the SFID code will be the same as the SSID code, but if a company has multiple entities, they may have a different SFID for each entity within the company



Glossary - Part 2 of 2

SPOC	Single Point of Contact is the Ford Motor Company corporate support center for resolving all IT issues.
TCP/IP	Transmission Control Protocol/Internet Protocol, the suite of communications protocols used to connect hosts on the Internet. TCP/IP uses several protocols, the two main ones being TCP and IP.
VDA	The German Association of the Automotive Industry (VDA) consists partly of automobile manufacturers and their development partners, the suppliers, and partly of the manufacturers of trailers, body superstructures and containers. VDA is also a data format used by Ford in Europe for EDI messages. For further information visit http://www.vda.de/
VPN	Virtual Private Network, is a common method of interconnecting private networks (LANs) over a Public Internet connection. It applies the open standard IPSEC protocol to authenticate the communication partner and encrypt the transmitted network data. Strong authentication and encryption ensures privacy and integrity of the communication while using an untrusted network (Public Internet).



Who supports what?

Problem

- ⇒ Data content
- ⇒ Data transmission
- ⇒ New EDI connection
- ⇒ Local EDI software problem

Contact

- Ford Application Owner
- GSEC (Global Supplier Electronic Communications)
- GSEC (Global Supplier Electronic Communications)
- EDI software provider

